



THE
ONYX
COLLECTION

Elegance for your bath

Showers – Lavatories – Tub Surround & Shower Walls – Other Bath Accessories
– Yes! Guaranteed Forever –

About The Onyx Collection

The Onyx Collection manufactures shower bases, shower wall panels, lavatories, tub surrounds, shower seats, accessories and trim to your specifications in almost any color, shape and size. Founded in 1985, the Onyx Collection now employs over 500 in Northeast Kansas. Quality products, our “Yes! Guaranteed Forever” guarantee, quick delivery, ease of installation and our unique chemistry and design have made us legends in the industry.



Yes! Guaranteed Forever





Lavatories - Rectangular Shape



Rectangular lavatories are available in almost any size, all Onyx colors, 4 edge styles, and 11 bowl styles. A single bowl or multiple bowls can be located where needed. A backsplash can be integral (4" tall or less) or separate (any height). Faucet hole(s) frequently are for a single hole, 4" spread, or 8" spread, but can be custom sized or located as you need, including an extra hole for a soap dispenser.



Venetian Bowl



Olympic Bowl

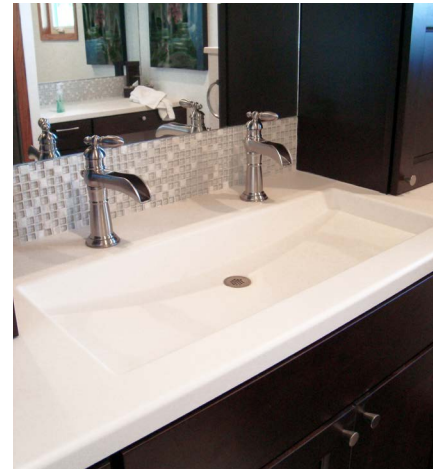

Atlantic Bowl

Edge Styles & Thickness Options

Edge



Thickness



Multiple Colors

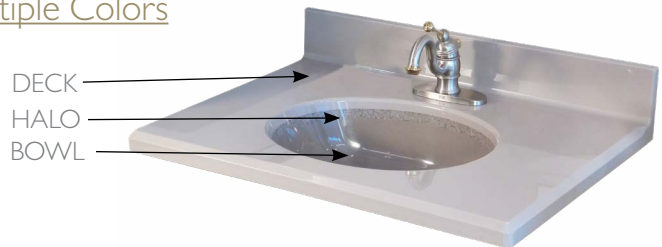

Bowl Styles

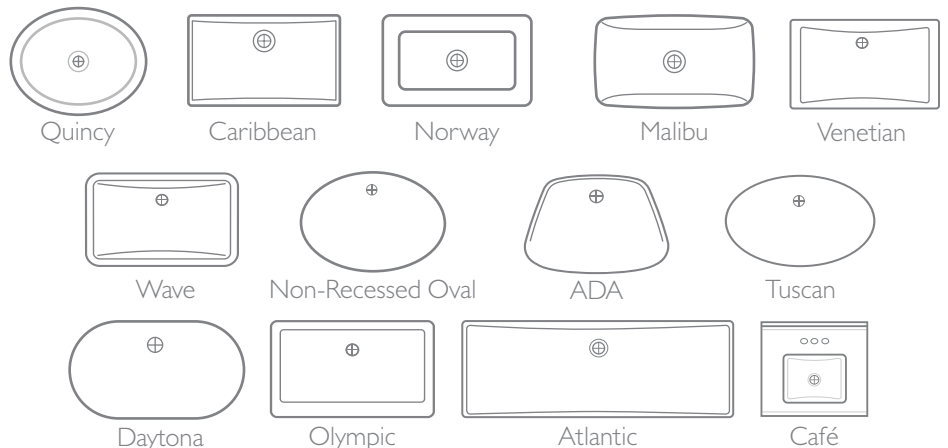

Lavatory Measuring Hints

- Start with cabinet dimensions
- For each end that is not against a wall, add 1/2" for overhang
- Add 1" for overhang in the front, (add 1 1/2" for cabinets with full overlay doors)
- Center bowl between cabinet doors

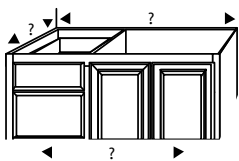

Custom lavatories can be almost any length, depth, thickness, or shape and can incorporate any of our bowl styles and edge styles. Your lavatory is made to order specifically to your needs.



Venetian Bowl



Oval Non-Recessed Bowl



Royale Non-Recessed Bowl



Venetian Bowl

Edge Styles & Thickness Options

Edge



Thickness



Shape Options

Custom lavatories can be ordered in almost any shape, size and configuration. The possibilities are endless...if you can dream it, we can make it.



Oval Non-Recessed Bowl

Bowl Styles

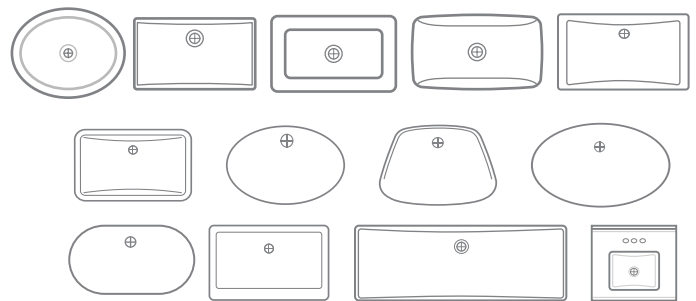

Oval Non-Recessed Bowl



Wave Bowl

Onyx Wall Panels are available in 5 finishes: Gloss, Stone Tile, Subway Tile, 8"x24" Wavy Tile, and Shiplap. Each finish style is priced the same. Panels are approximately 3/8" thick and come standard with 2 finished edges.

Shower kits are commonly 78", 84", 90", 96", 102" or 108" high.

Gloss

Our most popular finish, the smooth Gloss Finish gives a classic appearance with an easy to clean smooth surface. All colors are available in the Gloss Finish. Also, Inlay Stripes and Picture Inlays are available in the Gloss Finish.

Max sizes available:

- 82" W x 118 3/4" H.
- 118 3/4" W x 82" H.



Subway Tile

Subway Tile Wall Panel Finish is a smooth, flat tile design with faux grout lines. -- The size of the "tile" is 3" x 9 5/8" and the 1/4" wide grout groove is 1/32" deep.

Max sizes available:

- 82" W x 105 3/4" H.
- 87 5/8" W x 82" H.



Stone Tile

Our production mold was made from natural $11\frac{3}{8}'' \times 11\frac{3}{8}''$ stone tiles which gives each wall panel the look of stone tile without the worry of leaking grout seams. All colors are available in Stone Tile Finish.

Max sizes available:

- $82'' \text{ W} \times 105'' \text{ H}$.
- $105'' \text{ W} \times 82'' \text{ H}$.

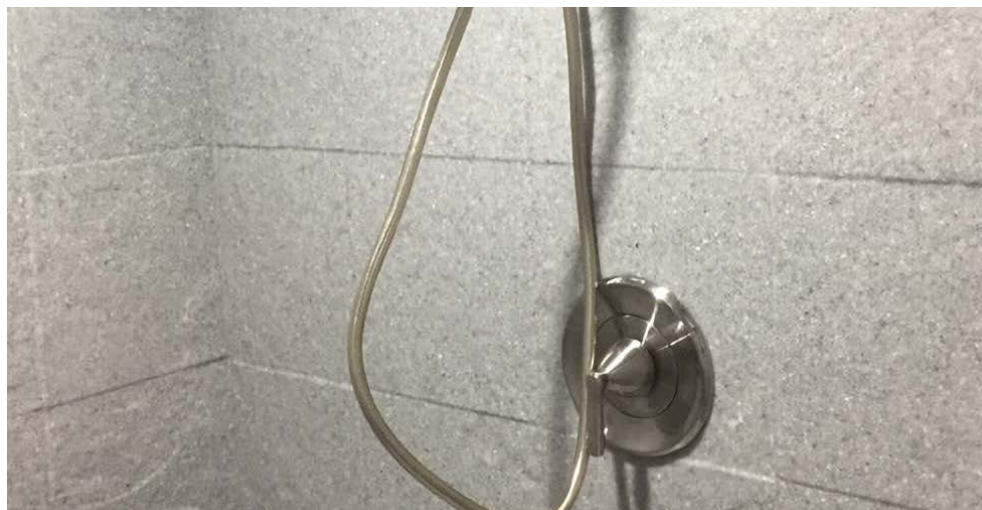

8'' x 24'' Wavy Tile

Actual tile size (not including any grout lines) is $7\frac{7}{8}'' \times 24\frac{1}{8}''$. The grout lines are $\frac{3}{16}''$ wide. Wavy Tile pattern can run horizontal or vertical.

Max sizes available:

- $82'' \text{ W} \times 105\frac{1}{8}'' \text{ H}$.
- $96\frac{3}{4}'' \text{ W} \times 82'' \text{ H}$.



Shiplap Finish

Smooth panel with $\frac{1}{4}''$ wide recessed groove. The spacing between the grooves is 5''.

Max sizes available:

- $82'' \text{ W} \times 110'' \text{ H}$.
- $96\frac{1}{8}'' \text{ W} \times 82'' \text{ H}$.

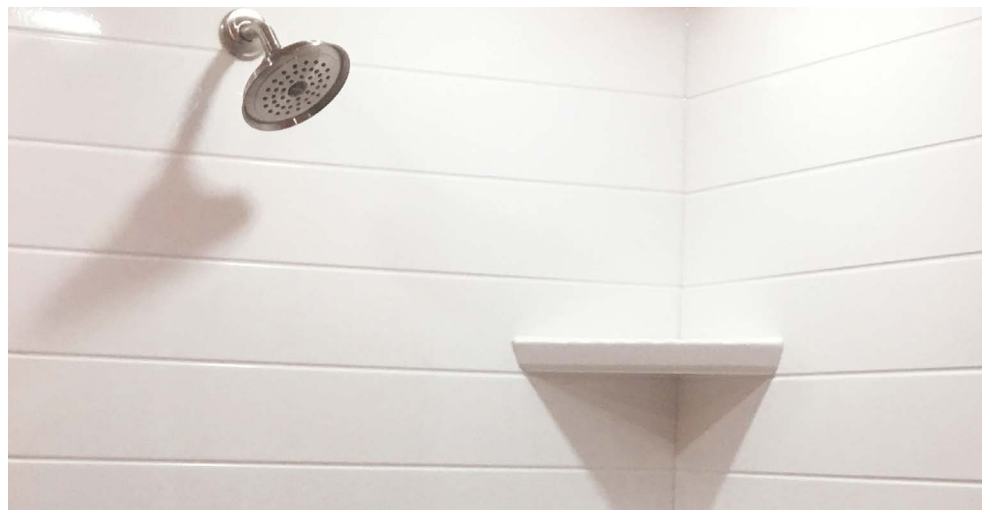

Shower Bases - Standard



A typical Onyx Collection "Standard" shower consists of a shower base and 3 wall panels (2 for Neo-Angle & Dual Curb). A ceiling panel may also be added. All the standard size shower bases and curb styles are listed in this section, along with shower kits which include the wall panels and adhesive & color match silicone for installation.

Curb Style Options

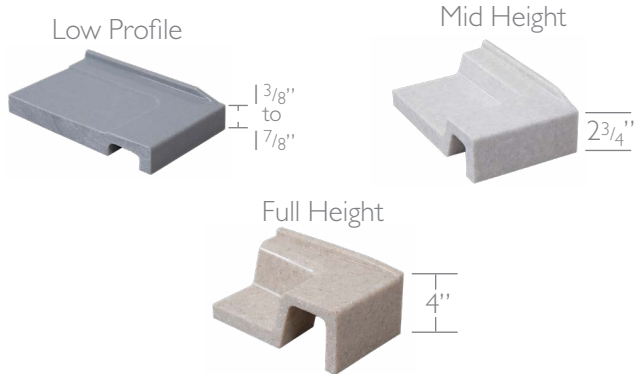

Shape Options

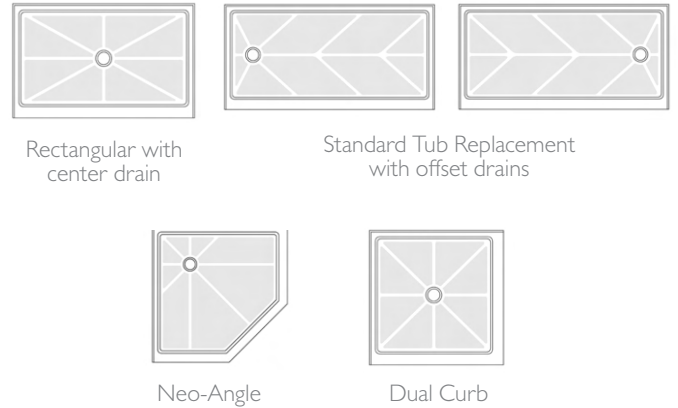

Center Drains

Available in many sizes, center drain standard shower base options will fit almost any bathroom design. A standard size will work for most remodels and can be matched with our wall panels, shower accessories and shower seats.

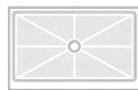



Available Styles & Sizes

Width x Depth

Low Profile	36 x 36	48 x 34	60 x 32
	38 x 37	48 x 36	60 x 34
	42 x 36	48 x 42	60 x 36
	42 x 42	48 x 48	60 x 42
	48 x 32	54 x 36	60 x 48

Add-on ramp available for all low profile bases

Mid Height	32 x 32	42 x 32	48 x 36	60 x 32
	36 x 32	42 x 34	48 x 42	60 x 34
	36 x 34	42 x 36	48 x 48	60 x 36
	36 x 36	42 x 42	54 x 32	60 x 42
	36 x 42	48 x 30	54 x 36	60 x 48
	36 x 48	48 x 32	54 x 42	72 x 36
	38 x 37	48 x 34	60 x 30	

Full Height	36 x 36	48 x 36	60 x 32
	42 x 36	48 x 42	60 x 34
	48 x 32	54 x 36	60 x 36
	48 x 34	60 x 30	

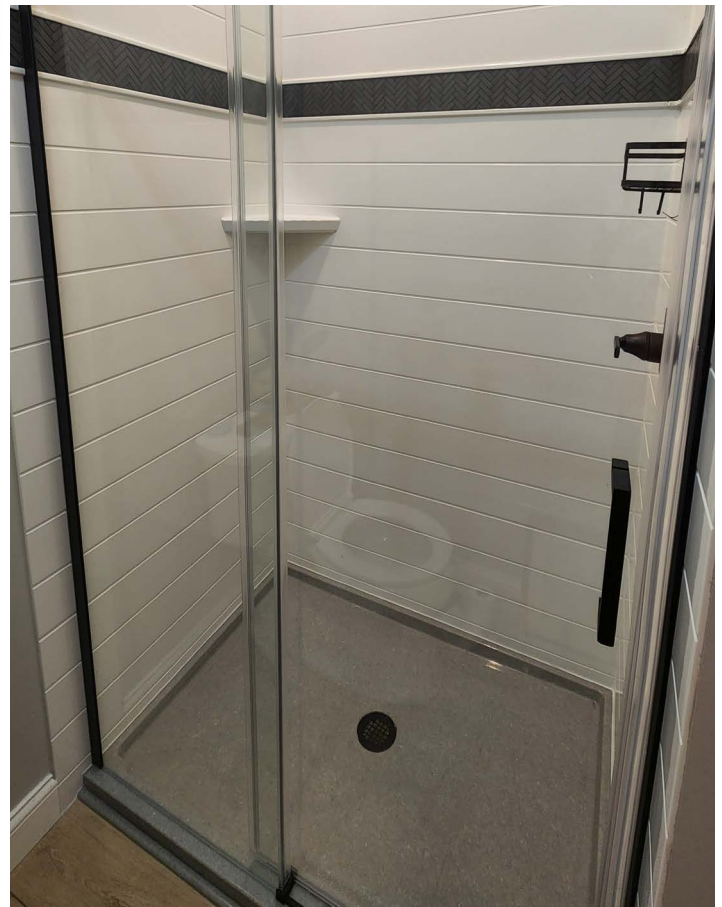

Standard base, Onyx Shiplap wall panels with Floating corner caddy

Shower Bases - Standard



Offset Drain Sizes

These shower bases are commonly used to replace bath tubs with offset drains and are available in Low Profile 1³/₈"", Mid Height 2³/₄"", and Full Height 4¹/₈"".

There are several unique sizes to fulfill the needed flexibility in the tub-to-shower remodels.



Low Profile Base

Available Styles & Sizes

Low Profile



Left Drain

Right Drain

60 x 30
60 x 32
60 x 34
60 x 36
60 x 42

60 x 30
60 x 32
60 x 34
60 x 36
60 x 42

Mid Height



Left Drain

Right Drain

60 x 30
60 x 32
60 x 34
60 x 36
60 x 42

60 x 30
60 x 32
60 x 34
60 x 36
60 x 42

Full Height



Left Drain

Right Drain

54 x 30
60 x 30
60 x 32
60 x 34
60 x 36

54 x 30
60 x 30
60 x 32
60 x 34
60 x 36



Neo-Angle

A typical Onyx Collection "Standard" Neo-Angle Shower consists of a Neo-Angle Shower Base and two Wall Panels. A ceiling panel may also be added. We have two Standard Neo-Angle shower bases. They are both in the Mid Height Style. For other sizes or configurations, see the custom showers section of this catalog where you will discover endless possibilities.



Available Styles & Sizes

Mid Height



38 x 38
42 x 42

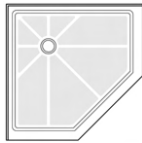

Standard Neo-Angle with Semi-Frameless Glass

Dual Curb

We have two Standard Dual Curb shower bases. They are both in the Mid Height style with a center drain. For other sizes or configurations, see the Custom Showers section of this catalog, where you will discover endless possibilities.



Mid Height



36 x 36
42 x 42

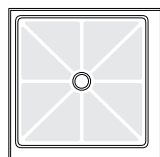

Curb

Curb



(Dual Curb with Frameless Door)

Installed Showers

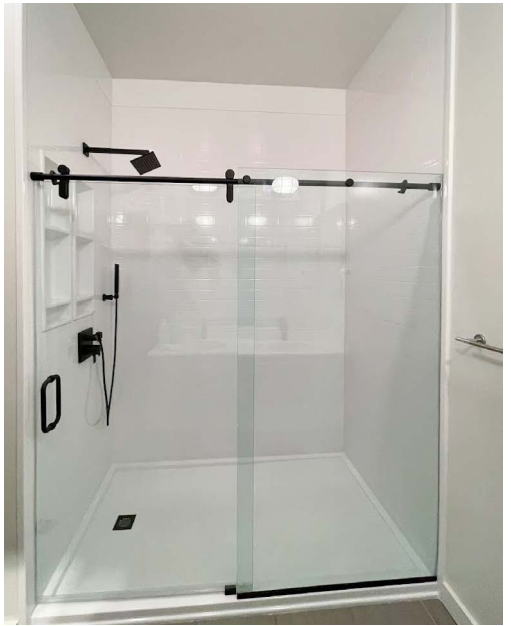

A typical Onyx Collection "Custom" Shower consists of a shower base and one panel for each wall. An endless variety of custom configurations are possible from traditional designs to elaborate walk-in designs. Any design can be enhanced with wider curbs for glass block walls, ceiling panels and even specially designed components for accessibility including ramped curbs, and low profile curbs.

Curb Options



The Custom Low Profile Curb height may be as low as 1³/₈" and as tall as 2¹/₄" depending on shower size. This lower curb height is good for easy access, adding a ramp, or for recessing into the floor for a curbless entry. The low profile curb has a slope back into the shower area and the shower area has a 1/4" per foot slope towards the drain.

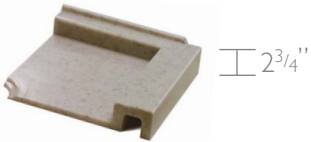

The Custom Mid Height Curb height is 2³/₄" tall. The Mid Height is designed with a more modern, straight line look and a lower, narrower curb for easier access and to give a little more room in the shower. It also has the benefit of working well with shower doors and curtains. The shower area has a 1/4" per foot slope towards the drain.

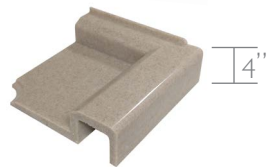

The Custom Full Height Curb height is 4" tall. This curb height works well with both shower doors and curtains. All curbs have a slope back into the shower area and the shower area has a 1/4" per foot slope towards the drain.



The add-on ramp can be used with any low profile shower base. It can be made to any length to accommodate your custom shower design and can be removed if not needed.



The integral ramp is a clean one piece design that makes easy access with wheel chairs. This ramp can be built into any of our shower bases.

Shape Options

With unlimited custom shapes available, all of our custom shower bases are cast in pieces to your specifications and then chemically bonded into a single unit for easy, worry-free installation.





Custom walk-in designs with offset curb and rear corner clip



Low Profile 3-Sided Base



Custom neo-angle base with dual return walls

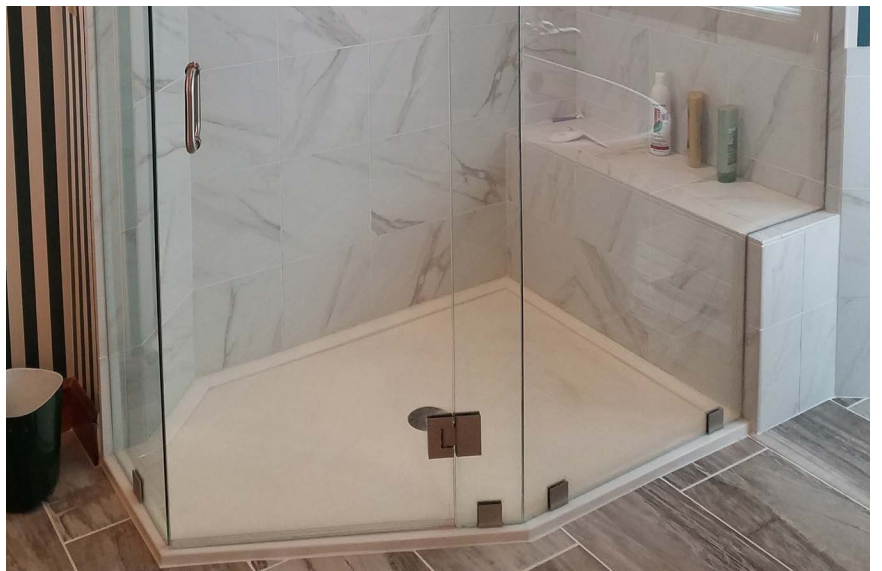

Custom Offset Neo Angle with Clipped Corner



Custom Dual Curb with Curved Clip

Fully Frameless - Hinged Doors

8" Pull Handles are standard
 Finish Options: Chrome, Brushed Nickel, Oil Rubbed Bronze & Matte Black
 3/8" thick: Clear, Obscure, & Tinted Glass
 Door Height: 72"
 Door must hinge on wall side
 There must be wood in walls where glass attaches

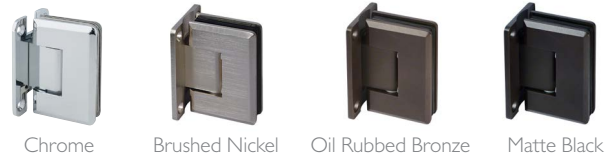
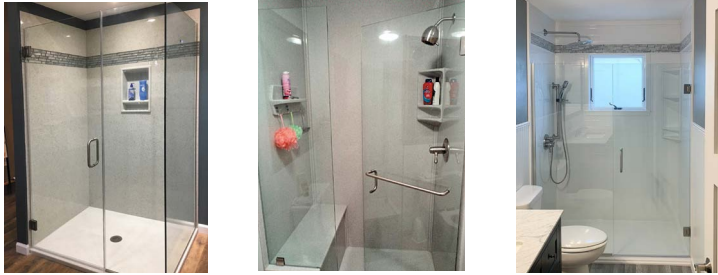

Fully Frameless - Barn Doors

Available in 3/8" clear, obscure & tinted glass
 Standard height is 74"
 Chrome, Brushed Nickel, Oil Rubbed Bronze & Black



Bypass Slider Doors - 1/4" Thick

Available in 1/4" Clear, Obscure, & Tinted Glass

Towel bar on inside & outside

Standard height is 73 3/4"

Chrome, Brushed Nickel, or Oil Rubbed Bronze



Important: Matte Black finish option is not available for door with bench seat or return panel.



Semi-Frameless - Hinged Doors

Available in 1/4" clear, obscure & tinted glass

Standard height is 71 1/2"

Finishes: Chrome, Brushed Nickel, & Oil Rubbed Bronze



Glass



Clear (1/4" Thick)
or 3/8" for Fully Frameless



Obscure Aquatex
(1/4" Thick Only)



Satin (1/4" Thick)
or 3/8" for Fully Frameless

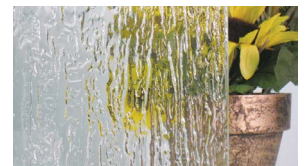

Rain (1/4" Thick)
or 3/8" for Fully Frameless

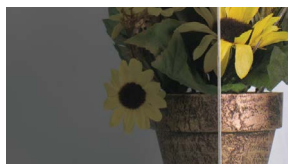

Smoke Gray (1/4" Thick)
or 3/8" for Fully Frameless

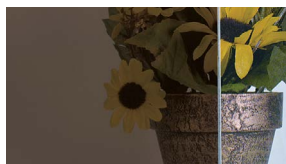

Smoke Bronze (1/4" Thick)
or 3/8" for Fully Frameless



Pattern 62 (1/4" Thick)
or 3/8" for Fully Frameless

Caddies & Shower Accessories

We offer various sizes and styles of bathroom shower soap or shampoo caddies, grab bars, robe hooks and foot rests.

Liberty Series



Pearl Series



Diamond Series



Shower Seats

Wall Mount

Liberty Corner Wall Mount seats come in 2 Styles, Regular 20" and Extended 13" x 25". When ordering the extended, please specify right or left.



20" Liberty Corner Seat



13" x 25" Liberty Extended Seat
(Right Shown)

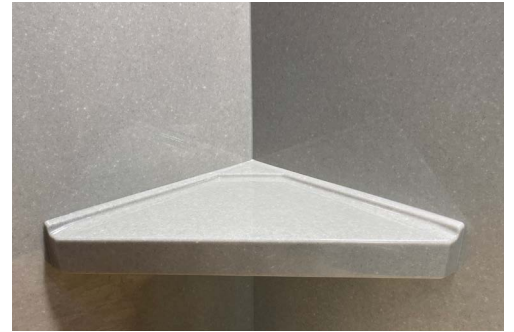

Corner Seat - Liberty Shown

Pearl Corner Wall Mount seats come in 2 Styles, Regular 20" and Small 15"

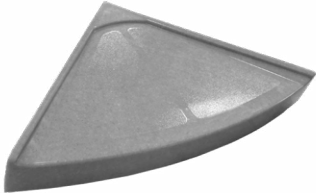

20" Pearl Corner Seat



15" Pearl Corner Seat

All shower seats are available in any of our colors and can be installed on Onyx or tile.

Built-In Bench

Bench seats can be installed with either standard or custom shower bases. A bench seat is 5/8" thick with 1/4" x 1/2" flange on wall sides & has a rounded front edge for comfort.

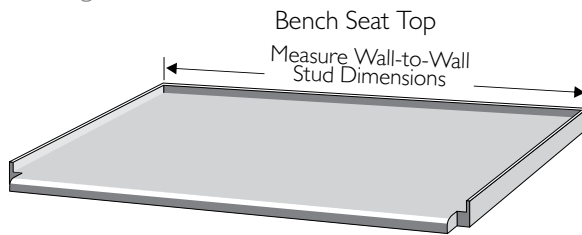

Open Bench Seat Shown

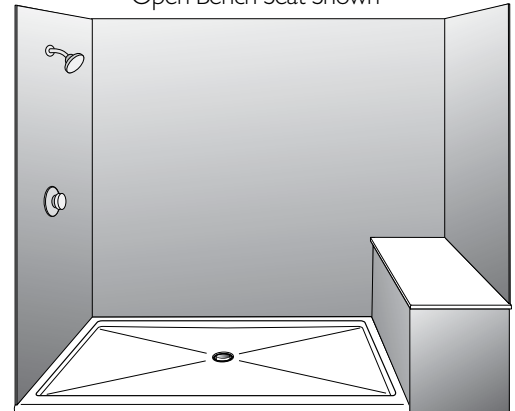

Decorative Trim

To accent your bathroom and shower, choose from our many styles and sizes of decorative trim.

Crown Molding & Corner Block



Casing - Windows & Doors



Chair Rail



Baseboard with Base Shoe



Base Shoe

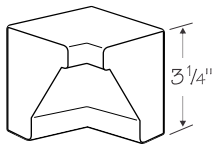
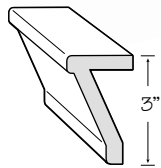

Liberty Crown Molding

Liberty Crown Corner Block

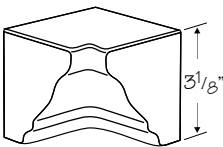
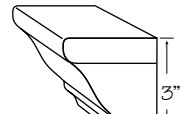
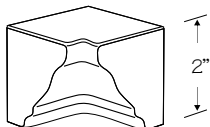
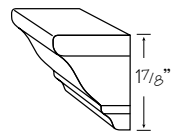

Classic Crown Molding

Classic Crown Corner Block

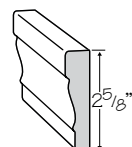

Case Molding

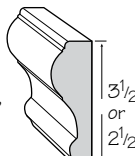

Chair Rail Molding

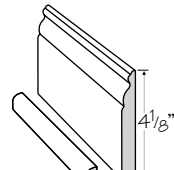

Baseboard & Shoe Molding

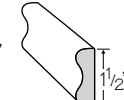

Cove Molding

Corner & Flat Trim

Inside Corner Trim



Edge Cap Trim



Outside Corner Trim



Flat Smooth Trim (3/8" Thick)



Available in: 2", 3", 4", 5", 5 1/2", 6", 8", & 12" widths. Custom widths also available.

Tile Trim



Available in:
4" x 4" pattern
6" x 6" pattern
5" x 12" pattern

Mosaic Tile Trim



Edge Cap Trim

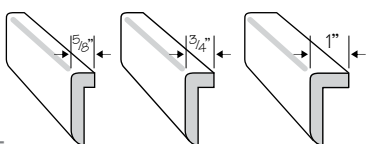

Outside Corner Trim

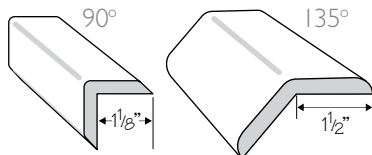

Inside Corner Trim

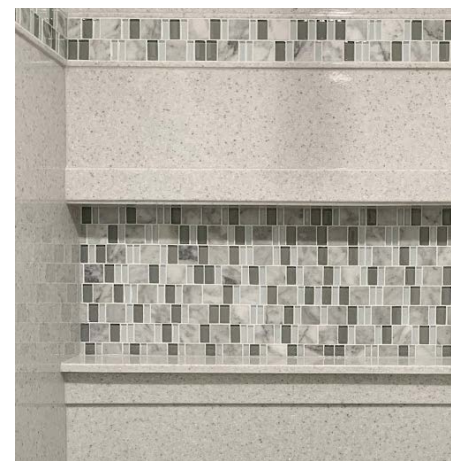
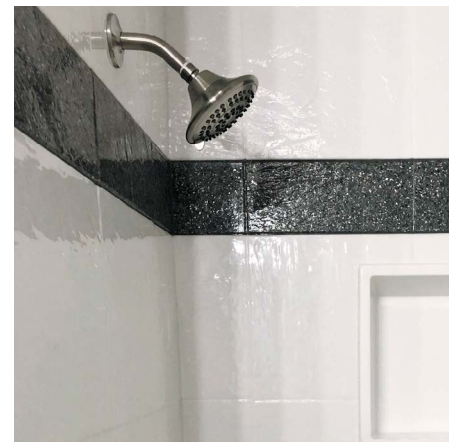
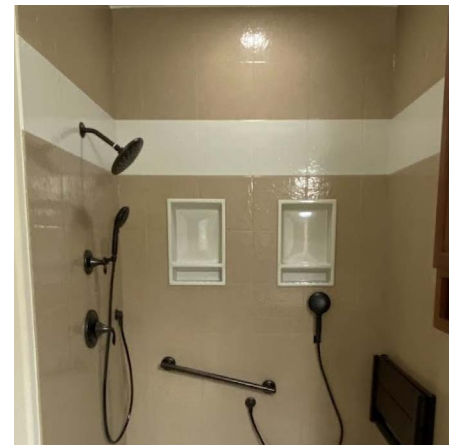
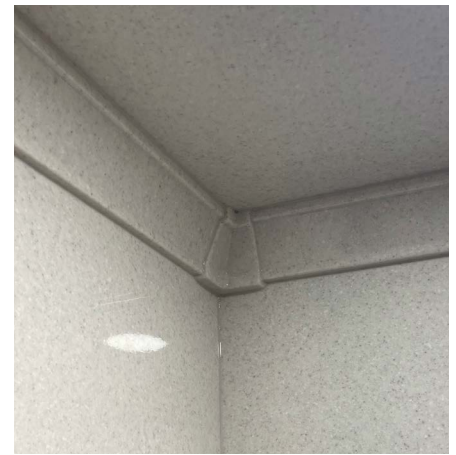
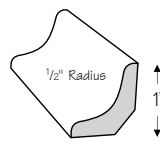

Mosaic Tile and Recessed Trim

The Mosaic Tile and Installation Kit work well with the Onyx Recessed Trim for Mosaic Tile.

The Onyx Recessed Trim for Mosaic Tile is available 5" and 7" tall with a recessed area intended to hold 4" and 6" mosaic tile.

The Tile is custom designed to match Onyx Color tones and is made in the USA.

The installation kit includes: Grout, drop cloth, squeegee, tape, silicone, sponge & bucket.

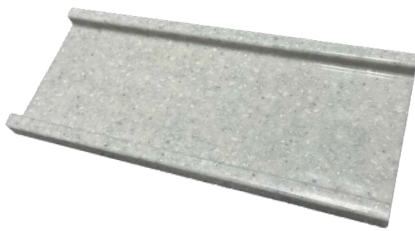
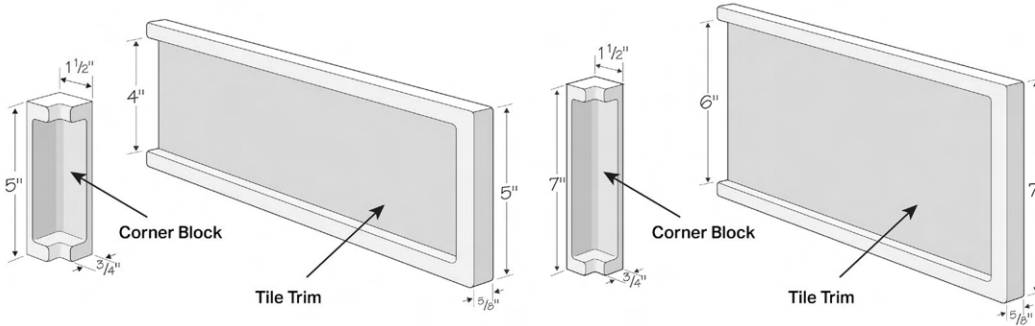

Recessed Trim for Mosaic Tile



Installation Kit



Colors and Styles Available

White / Gray
- Linear-



White / Gray
- 2 Row Combo -



Black /Charcoal
- Linear-



Black /Charcoal
- 2 Row Combo -



Light Neutral
- Linear-



Light Neutral
- 2 Row Combo -



Medium Neutral
- Linear-



Medium Neutral
- 2 Row Combo -



Dark Neutral
- Linear-



Dark Neutral
- 2 Row Combo -





THE
ONYX
COLLECTION

The Onyx Collection
105 Broadway St. Belvue, KS 66407
800-669-9867 (phone) 785-456-8604 (phone)
800-393-6699 (fax) 785-456-8204 (fax)

www.onyxcollection.com